

4-H Harness Goat Project Supplement

The age of your goat determines which level of the project you do for the year (age as of January 1):

- Project I Kid under 1 year
- Project II Over 1-2 years
- Project III Over 2-3 years
- Project IV Over 3-4 years
- Project V Over 4 years



Harness Project I

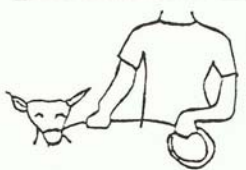

Coil

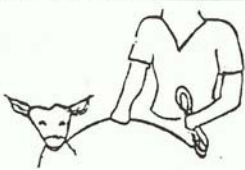



Figure-8

STANCE OF GOAT



Feet squared and goat should look alert

Hold the excess lead in your left hand, wrapped in a coil or figure-8 fashion. Keep your hand near or against your belt.

SHOWING AND JUDGE'S EXAMINATION

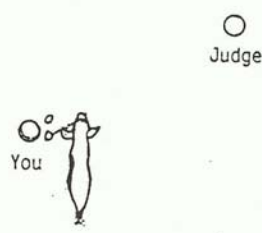
1) 

1) Face the goat when the judge is on the right. Stand with heels together and look proud.

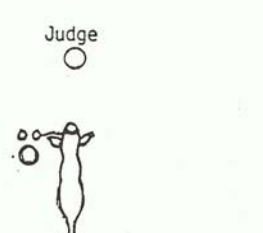
2) 

2) When the judge stands in front of your animal - face the judge and wait till he passes before changing sides.

3) 

3) When the judge has passed, switch sides and resume position number 1.



Harness Project I

JUDGING AT LEAD

NOTE: Do Not switch sides when at lead.

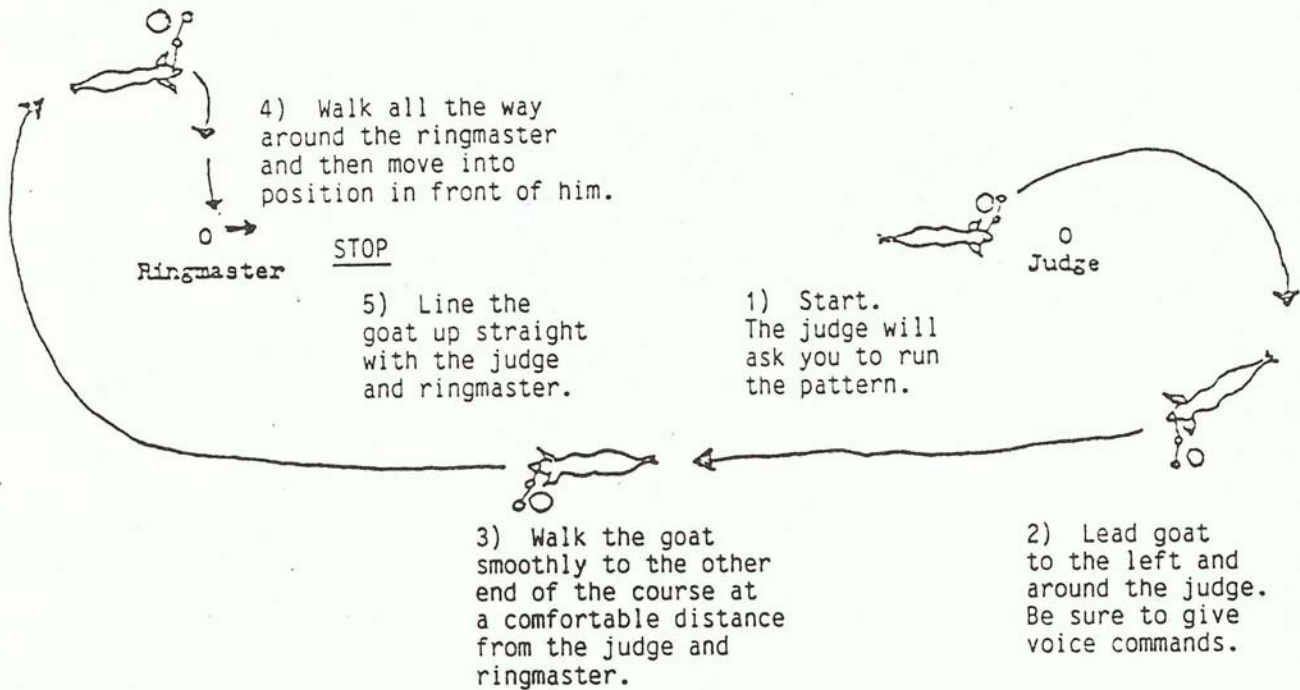

JUDGING MANEUVERABILITY

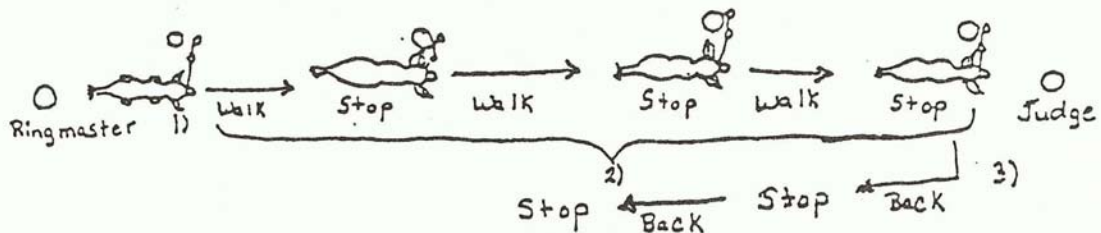

1) The goat's feet should be fairly square. If they are out of place try walking the goat forward a little. If they are still not correct use your hand to straighten them.

2) Walk and stop the goat three times. On the third stop, pause a moment and proceed with procedure 3.

3) Back and stop the goat 2 times. After you stop the second time, square the animal's feet and stand for inspection.

NOTE: The animal should lead calmly and willingly. The goat should not have to be tugged or pulled through the course. He should respond to voice commands.

Harness Project II

Score Card - Second Year

1-5 points for scoring (five is best score)

Circle Pattern

- Proper stance when starting pattern _____ 5 points
- Goat pulls cart smoothly and willingly _____ 5 points
- Gives voice and rein commands _____ 5 points
- Correct pattern and fairly straight alignment between judge and ringmaster _____ 5 points

Line Pattern

- The serpentines are smooth and close to the same size _____ 5 points
- Three loops are completed _____ 5 points
- Voice and rein commands are given _____ 5 points
- Goat responds to the commands _____ 5 points
- Person and goat in proper stance at completion of pattern _____ 5 points
- Person handled goat smoothly but firmly with pride _____ 5 points

Total points (50 possible) _____

Comments:

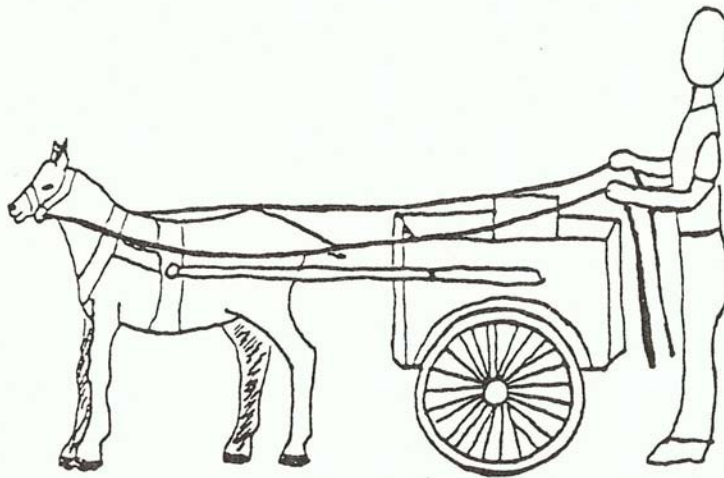
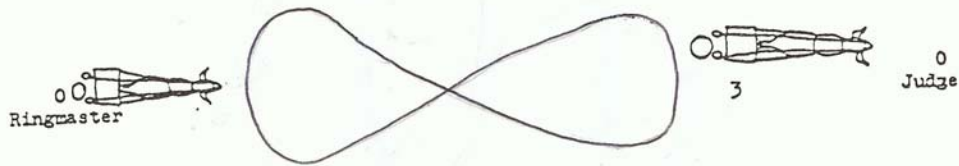

Figure - 1

1) Proper Stance. You should stand with legs together. Stand tall with arms stretched comfortably in front holding the reins. The goat should look alert and its legs should be fairly square. The important factor is to establish and keep control of the goat at all times.

Harness Project II

FIGURE 8 PATTERN



Demonstrate voice commands.

Left, right, go-back.

Stop - as signaled by the judge

Figure 8 with use of cones.

Circle Pattern

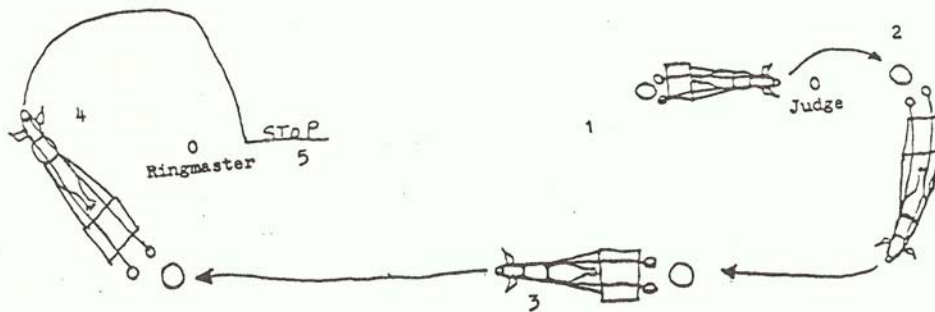

1) Stand before the judge in proper form. The judge will ask you to run the pattern.

2) Go left of the judge and around the back of the judge. Be sure to give voice commands to the goat when you are directing it.

3) Continue driving the goat to the other end of the arena to the ringmaster.

4) Continue behind the ringmaster. The goat should be pulling smoothly and responding to your direct commands.

5) Pull in front of the ringmaster so that the head of the goat is facing the judge. Try to be in fairly straight alignment with the judge and ringmaster. Stop and wait for the judge's hand signal to begin line pattern.

Harness Project III

Score Card - Third Year

1-5 points for scoring (five is best score)

First Part

- Proper stance when starting pattern _____ 5 points
- Goat pulls cart and person willingly _____ 5 points
- Voice and rein commands are given _____ 5 points
- Correct first part and fairly straight between judge and ringmaster _____ 5 points

Backing

- Pulls to center before backing _____ 5 points
- Smooth, fairly straight _____ 5 points

Second Part

- Reversing field with correct procedure _____ 5 points
- Person is maintaining control of the animal _____ 5 points
- The person drives the goat all the way around the judge before parking _____ 5 points
- Person handled goat with good ability and pride _____ 5 points

Total points (50 possible) _____

Harness Project III

Riding in cart:

- Figure 8 with cones
- Walk over tarp
- Demonstrate voice commands

RIDING IN CART

First Part

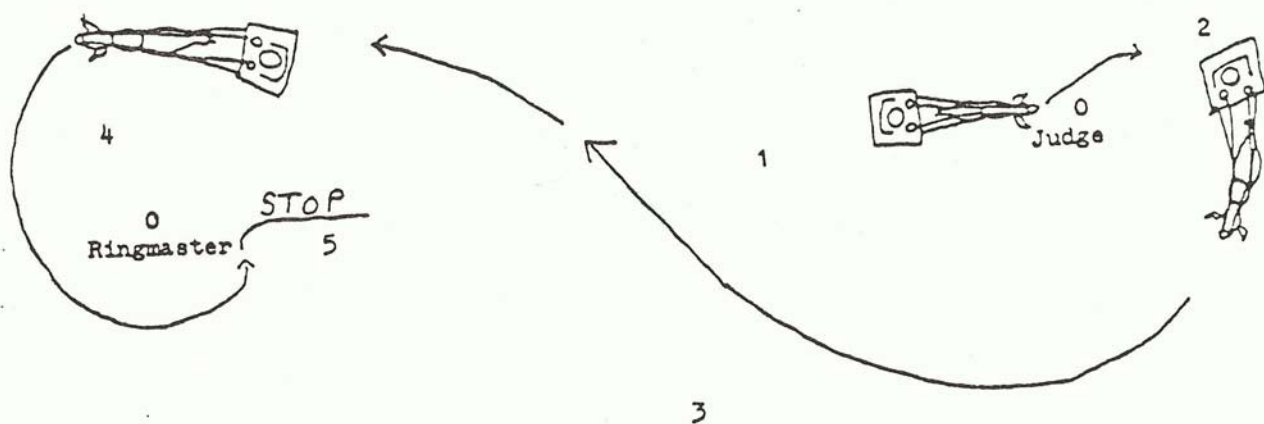

1) Stand before the judge in proper form. The judge will ask you to run the pattern.

2) Go left of the judge and around the back of the judge. Be sure to give vocal and rein commands to the goat.

3) Go through the center of the ring. You are attempting to make a figure eight. Your goat should drive smoothly.

4) Continue behind the ringmaster and to point 4.

5) Pull in front of the ringmaster so that the head of the goat is facing the judge. Stop and wait for the judge's hand signal before starting second part.

Harness Project III

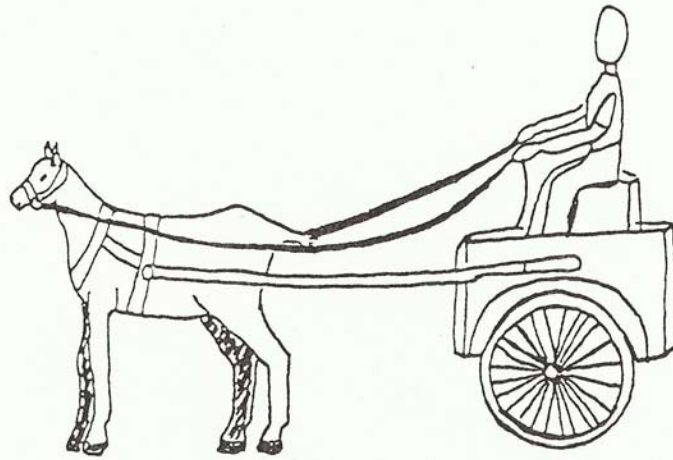
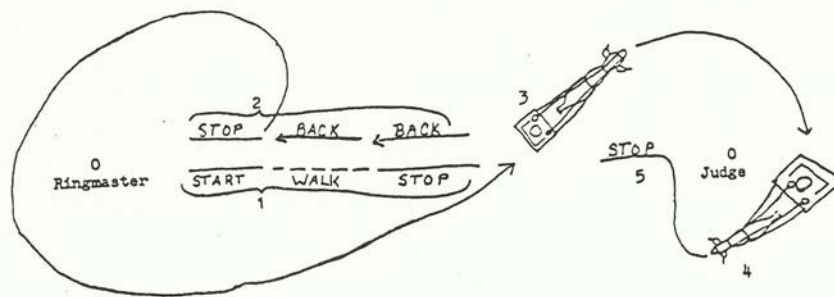

Figure - 1

1) Proper Stance. You should sit erectly in the cart holding the reins comfortably, but firmly. The goat should look alert and feet should be fairly square. The important factor is to have good control over the animal at all times.

Second Part



1) After the judge's signal, walk forward to the center of the ring. Stop your goat.

2) Back your goat to the point at which you started in front of the ringmaster and stop.

3) Drive your goat to the left and proceed behind the ringmaster. Then continue to reverse the pattern through the middle of the ring.

4) Continue to walk all the way around the judge.

5) Walk the goat up to the judge, so that it is facing the judge. Stand for inspection.

Harness Project IV

Voice Commands

Obstacle course - which includes walk over tarp, mail box stop - driveway + Bridge.

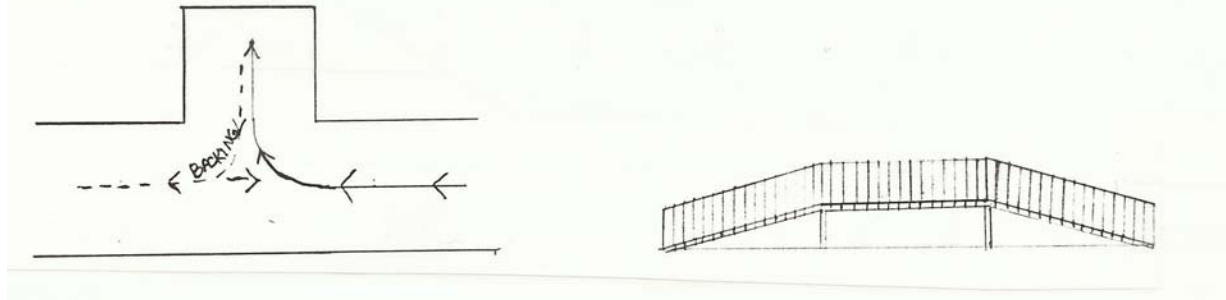

Harness Project V

Everything above plus teeter-totter.

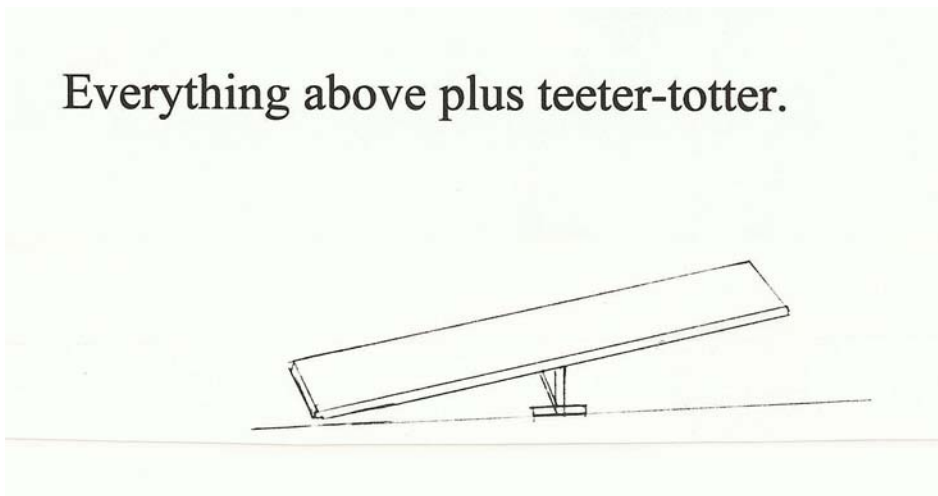

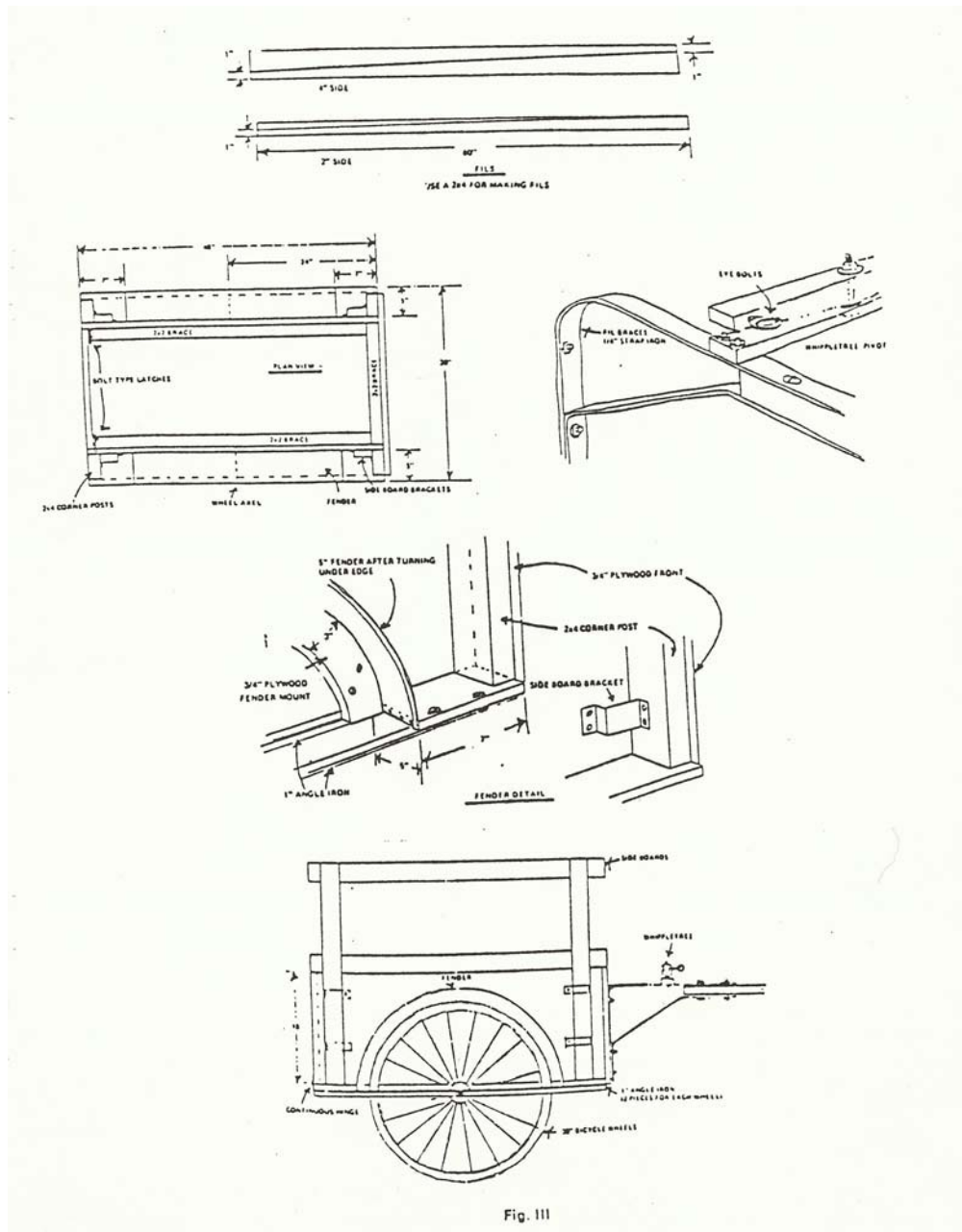

Fig. III

Acknowledgements:

Adapted by: Vicki Reed, Extension Educator,
4-H Youth Development

Updated 2015



Muskingum County Extension Office
225 Underwood St
Zanesville, OH 43701
Phone: 740-454-0144